

FP06P

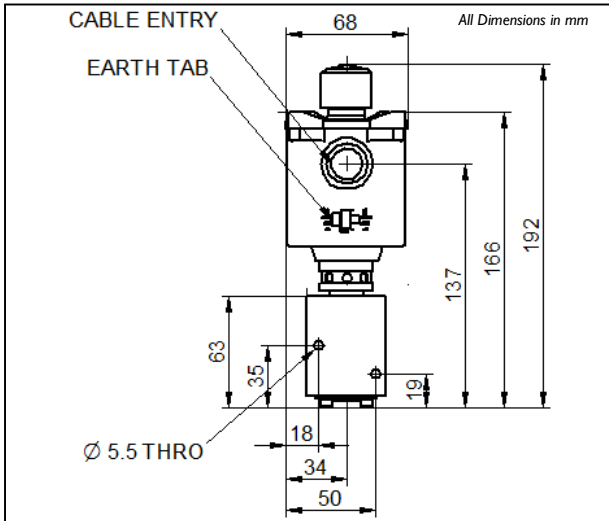

Dimensional Drawing



Schematic

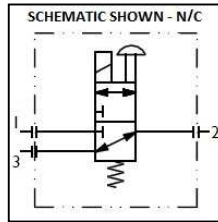

Wiring

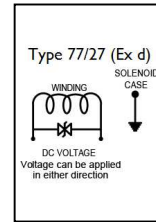

Rendering

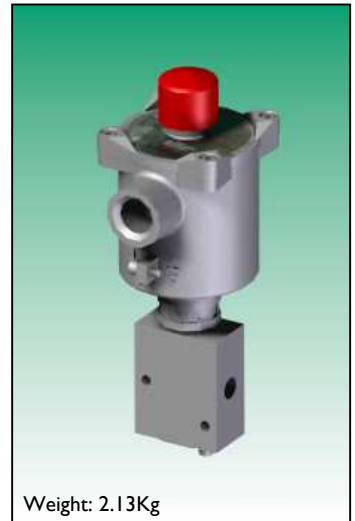

Certification



FP06P-SI-04-32-NU-V-77A-24D-M-35

FP06P	Direct Acting Solenoid Valve	Model Code
SI	145 psi / 10 bar Maximum Valve Pressure	Operator
04	1/4" Body Ported - Stainless Steel	Connections
32	3-way, 2-position	Valve Configuration
NU	Normally Universal	Valve Configuration
V	Viton -20°C to +90°C	O-ring Material
77	Ex d	Solenoid
A	ATEX/IECEx Dual Certified/Labelled	Solenoid Approval
24D	24VDC	Voltage
M	Electrical to switch or temporary manual override	Options
35	3.5 Watts	Power
	M20 x 1.5 Cable Entry	Cable Entry
	NPT Ports	Port Type
	No Identifier	Identifier
FP06P -SI -04 -32 -NU -V -77 A -24D -M -35		Model Number

Solenoid T-Rating

Ex d IIC Gb	T4 T135°C	(-60°C ≤ Tamb ≤ +90°C)
Ex tb IIIC Db	T5 T100°C	(-60°C ≤ Tamb ≤ +55°C)
	T6 T85°C	(-60°C ≤ Tamb ≤ +40°C)

This is a bespoke datasheet. For further details on the complete range, please refer to catalogue: Direct & Indirect Acting Solenoid Valves Models FP03P, FP06P, FP10P, FP12P, BXS & SPR

Accuracy of information
We take care to ensure that product information in this catalogue is reasonably accurate and up-to-date. However, our products are continually developed and updated so to ensure accurate and up-to-date information please refer to the product catalogue issue list on our web site or contact a member of our sales team.

When selecting a product, the applicable operating system design must be considered to ensure safe use. The products function, material compatibility, adequate ratings, correct installation, operation and maintenance are the responsibilities of the system designer and user.

Quality Assurance
All Bifold products are manufactured to a most stringent QA programme to ensure that every product will give optimum performance and reliability. We are third party certified to BS EN ISO 9001:2008. Functional test certificates, letter of conformity and copies of original mill certificates, providing total traceability are available on request, to BS EN 10204 3.1 where available. We reserve the right to make changes to the specifications and design etc., without prior notice.

